

CHV EFSNK C TO

CHIVE Tap Range Chive Easyfit Sink Mixer Chrome Tap Only



Features:

- Long life and easy to use 1/4 turn ceramic disc valves
- Product supplied without Easyfit base
- Minimum working pressure of 0.3 bar

Product Certifications:



WRAS Cert. Number: 1609025
WRAS Expiry Date: 30/09/2021



For more products, visit our website:
<http://www.bristan.com>



Specification

Product Type:	Kitchen Taps
Main Construction Material:	Brass
Mount Type:	Deck Mounted
Handle Type:	Lever Handles
Connection Inlet:	1/2" BSP Flexible Tails
Connection Outlet:	Flow Straightener
Number of Tap Holes:	1
Valve/Cartridge Type:	1/2" Ceramic Disc Valve
Plumbing System Requirements:	Suitable for all plumbing systems
Minimum Dynamic Pressure (bar):	0.3 bar
Maximum Dynamic Pressure (bar):	5.0 bar
Maximum Hot Water Temperature °C:	65°C
Maximum Static Pressure (bar):	10 bar
Flow Type:	Single Flow
Isolation Included:	Yes

Dimensions (measurements in mm)

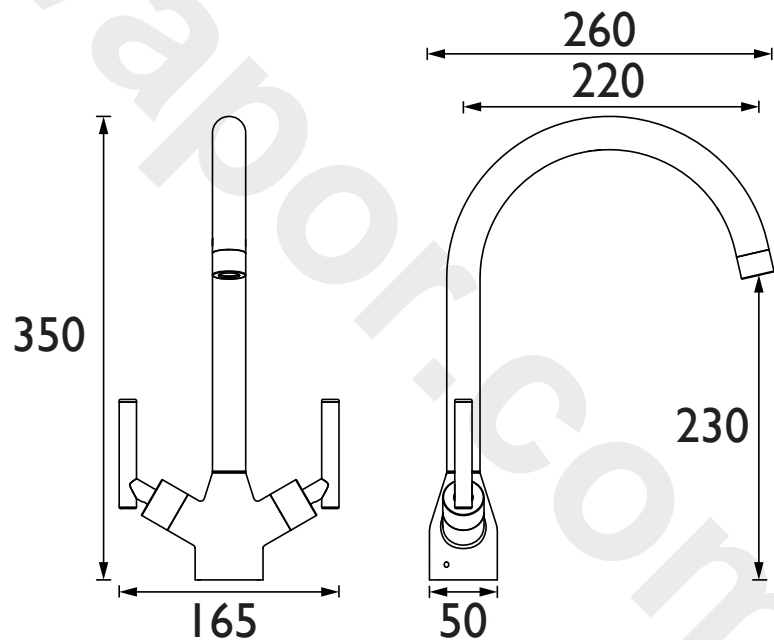

Flow Rates (l/min)

System Pressure (bar)	0.3	0.5	1	2	3	5
CHV EFSNK C TO (mixed)	10.4	13.4	19	26.9	32.9	42.5

TECHNICAL DATA SHEET



BRISTAN

D2